

STUDIO 90 - STUDIO 90^{PLUS}
MIDI PEDALBOARD

FATAR



Instruction Manual

FATAR

INDICE



Instruction Manual

ITALIANO

ENGLISH

DEUTSCH

STUDIO 90

SPLIT	Pag. 2	SPLIT	Page 14	TRENNUNG	Pag. 32
TRANSPOSE	" 2	TRANSPOSE	" 14	TRANSPOSER	" 32
DATI TECNICI	" 2	TECHNICAL DATA	" 14	TECHNISCHE DATEN	" 32

STUDIO 90^{PLUS}

CARATTERISTICHE	Pag. 3	INTRODUCTION	Page 15	EIGENSCHAFTEN	Pag. 33
RESET GENERALE	" 4	FEATURE LIST	" 15	GENERALPROGRAMMIERUNG	" 34
COLLEGAMENTI	" 4	CONNECTIONS	" 16	ANSCHLÜSSE	" 34
ACCENSIONE	" 4	SWITCHIN ON - NOTE <small>RESET P.</small>	" 17	NETZANSCHLÜSSE	" 34
USCITE MIDI	" 4	SECTION I: GETTING STARTED	" 18	MIDI-AUSGÄNGE	" 34
INGRESSO MIDI	" 4	LET'S GET STARTED	" 18	MIDI-EINGANG	" 34
PARAMETRI E VALORI	5	PROGRAMS	" 18	PARAMETER UND WERTE	35
PROGRAMMAZIONE:		PARAMETERS	" 19	DIE PROGRAMMIERUNG:	
SPLIT POINT	" 6	SPLIT LEFT-SPLIT RIGHT	" 19	SPLITPUNKTE	" 36
TRANSPOSE	" 8	TRASPOSER	" 21	TRANSPOSE	" 38
OCTAVE	" 9	OCTAVE	" 21	OKTAVE	" 39
CHANNEL MIDI	" 9	CHANNEL MIDI	" 22	CHANNEL MIDI	" 39
PRESET	" 10	PRESET	" 22	PRESET	" 40
FOOT-SWITCH/PITCH & MODULATION CONTROL	" 10	FOOT-SWITCH CONTROL	" 23	FUSSTASTER MODE CONTROL	" 40
VEL. SENS. TOUCH	" 10	VEL. SENSITIVITY	" 23	VEL. SENS. TOUCH	" 40
VEL. SENS. RELEASE	" 10	SECTION II: SAMPLE SET-UP	" 24	VEL. SENS. RELEASE	" 40
		MIDI IMPLEMENTATION CHART	" 27		

MIDI PEDALBOARD

DATI TECNICI	Pag. 11	FEATURES	Page 29	DIE TECHNISCHE DATEN	Pag. 41
CONNESSIONI	" 11	CONNECTIONS	" 29	ANSCHLÜSSE	" 41
PROGRAMMAZIONE:		PROGRAMMING:		DIE PROGRAMMIERUNG:	
POSIZIONE DELLE OTTAVE	" 12	OCTAVE	" 30	1.0 OKTAVLAGE	" 42
CANALE MIDI	" 12	MIDI CHANNELS	" 30	2.0 MIDI-KANAL	" 42
CAMBIO PRESET	" 12	PRESETS EXTENSION SWITCH	" 30	3.0 WETTERSCHALTEN DER KLANGFARBEN	" 42

STUDIO 90

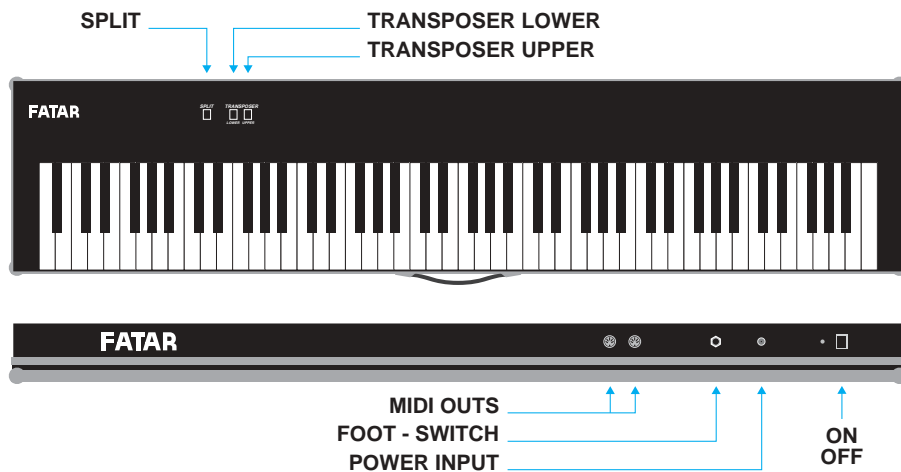

► SPLIT

Per «splittare» la tastiera in due parti, è sufficiente premere la nota dalla quale si desidera dividere la tastiera, e premere quindi il tasto «SPLIT».

Ovviamente, una volta divisa, la tastiera si separa in due parti; la parte bassa (LOWER), sarà sul canale MIDI 1, mentre la parte alta (UPPER), sarà sul canale MIDI 2.

Premendo SPLIT senza nota, tutta la tastiera verrà trasmessa sul canale MIDI 1.

► TRANSPOSER

LOWER: per trasporre la parte lower, basta premere la nota a cui si vuol far corrispondere il LA iniziale, quindi premere il tasto «LOWER».

UPPER: per trasporre la parte upper, premere la nota alla quale si vuol far corrispondere il primo tasto dello SPLIT, quindi premere «UPPER».

Quando si fa lo «SPLIT», avviene una trasposizione automatica: la parte «LOWER», si alza di un'ottava, mentre la parte «UPPER» si abbassa di un'ottava.

► DATI TECNICI

L'alimentazione avviene tramite un ADAPTER standard con una tensione d'uscita che può variare da 9 a 12 volt (continui), e una corrente minima di 350 mA. Abbiamo provveduto inoltre a fornire la tastiera di due uscite midi parallele per poter avere la possibilità di pilotare direttamente due strumenti esterni. La tastiera è dotata inoltre di un jack "FOOT-SWITCH" al quale si può collegare un pedale OFF-ON che abiliterà l'effetto sustain via midi ai sintetizzatori ed expanders più diffusi in commercio.

STUDIO 90^{PLUS}

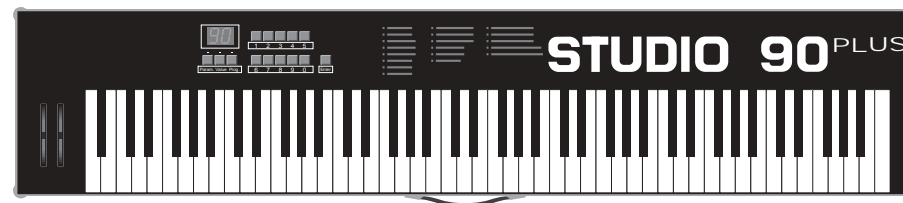

► CARATTERISTICHE

- Alimentazione: 220/240 Volts
- Fusibile di protezione/ 500 mA
- 88 Tasti pesati (Studio 90 Plus)
- Range Dinamico (00-99)
- Controllo dinamico al rilascio (00-99)
- Misure originali di un vero pianoforte
- Tocco dinamico come un vero pianoforte
- Due punti di divisione della tastiera (Split Point)
- Trasposizione per semitoni
- Trasposizione per ottave
- Tre uscite midi
- Pedale di controllo Foot/Switch
- Pedale cambio programmi
- Controlli di Pitch e Modulations
- 16 Canali MIDI esterni a scelta
- 100 programmi
- Display di controllo
- Flightcase
- Cabinet

▶ **RESET GENERALE (STUDIO 90 Plus)**

Spegnere la tastiera.

Tenere premuti i tasti "ENTER" e "1" della tastiera numerica.

Sempre tenendo premuti i suddetti tasti, riaccendere la tastiera.

Importante: una volta resettata la tastiera, tutti i programmi vengono cancellati ed entra in funzione un programma di default.

▶ **COLLEGAMENTI**

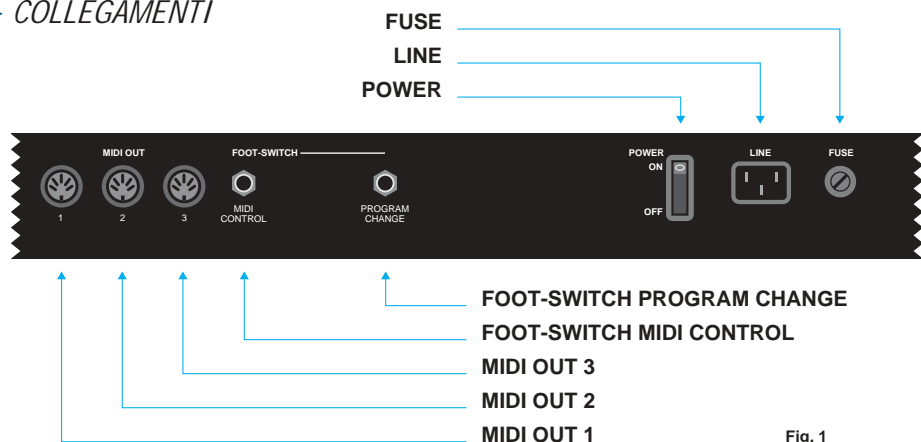

Fig. 1

▶ **ACCENSIONE**

Per accendere lo strumento, collegare il cavo di alimentazione nell'ingresso "LINE".
Per capire bene le connessioni, vedi il Fig. "1".

▶ **USCITE MIDI**

Le uscite MIDI sono tre per la STUDIO 90 Plus. Queste sono collegate in parallelo, così da permettere all'utente di formare più di una catena MIDI.

▶ **PARAMETRI E VALORI DELLA STUDIO 90 Plus**

▶ PARAMETRO	▶ FUNZIONE	▶ VALORE
▶ 00	▶ Split Sinistro	▶ 00-88
▶ 01	▶ Split Destro	▶ 00-88
▶ 02	▶ Transposer 1	▶ 00-11
▶ 03	▶ Transposer 2	▶ 00-11
▶ 04	▶ Transposer 3	▶ 00-11
▶ 05	▶ Octave 1	▶ 70-00-07
▶ 06	▶ Octave 2	▶ 70-00-07
▶ 07	▶ Octave 3	▶ 70-00-07
▶ 08	▶ Midi out 1	▶ 01-16
▶ 09	▶ Midi out 2	▶ 01-16
▶ 10	▶ Midi out 3	▶ 01-16
▶ 11	▶ Preset 1	▶ 00-99
▶ 12	▶ Preset 2	▶ 00-99
▶ 13	▶ Preset 3	▶ 00-99
▶ 14	▶ FT.SW. Control 1	▶ 00=off FS/Mod 01=on FS off Mod 02=off FS on Mod 03=on FS Mod
▶ 15	▶ FT.SW. Control 2	
▶ 16	▶ FT.SW. Control 3	
▶ 17	▶ Vel. Sens. Touch	▶ 00-99
▶ 18	▶ Vel. Sens. Release	▶ 00-99

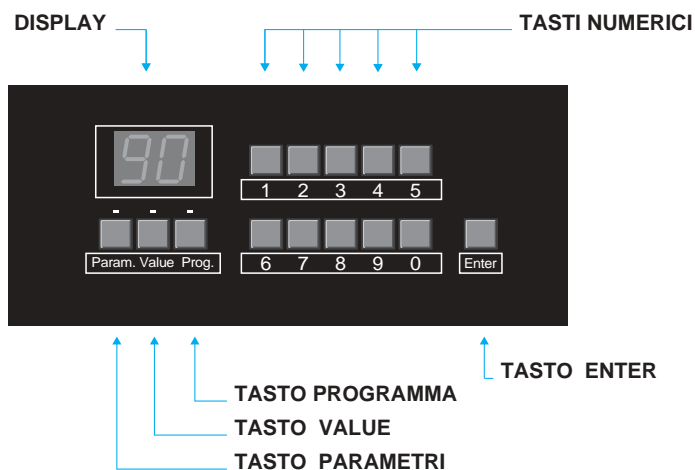

► **SPLIT POINT - Punto di divisione (Parametro 00 e 01).**

La tastiera Studio 90 Plus, ha due punti di divisione completamente liberi di essere programmati. Su questo terreno, ci sono parametri contrassegnati con 1,2 e 3. Il numero uno è sempre la zona di sinistra della tastiera, il due è il centro e il tre la parte destra. Se è collocato solo il punto di divisione sinistro, sono attive la zona 1 (sinistra) e la zona 2; se è fissato il punto di divisione destro, sono attive la zona 2 (a sinistra) e la zona 3 (destra).

Se il parametro 00 (Punto di divisione sinistro) è collocato sul valore 01 e il parametro 01 è collocato sul valore 87, l'intera tastiera può essere suonata con un solo suono, poiché è solo la zona 2 della tastiera in funzione attiva.

Accanto a questo primo orientamento "normale" ci sono ancora due diverse possibilità.

Fig. B la parte sinistra e destra della tastiera si lasciano suonare nello stesso orientamento. La zona centrale può suonare così tutti i tre canali MIDI contemporaneamente;

Fig. C collocare la voce sopra il parametro 03 (transposer 2) e lo 06 (ottava 2). Porre il punto di divisione destro e sinistro sullo stesso tasto. La tastiera verrà divisa in due parti; destra e sinistra, modificabili con i parametri contrassegnati con i numeri 1 e 3, mentre contemporaneamente, tutta la tastiera potrà avere un suono di sovrapposizione modificabile con i parametri contrassegnati dal numero 2.

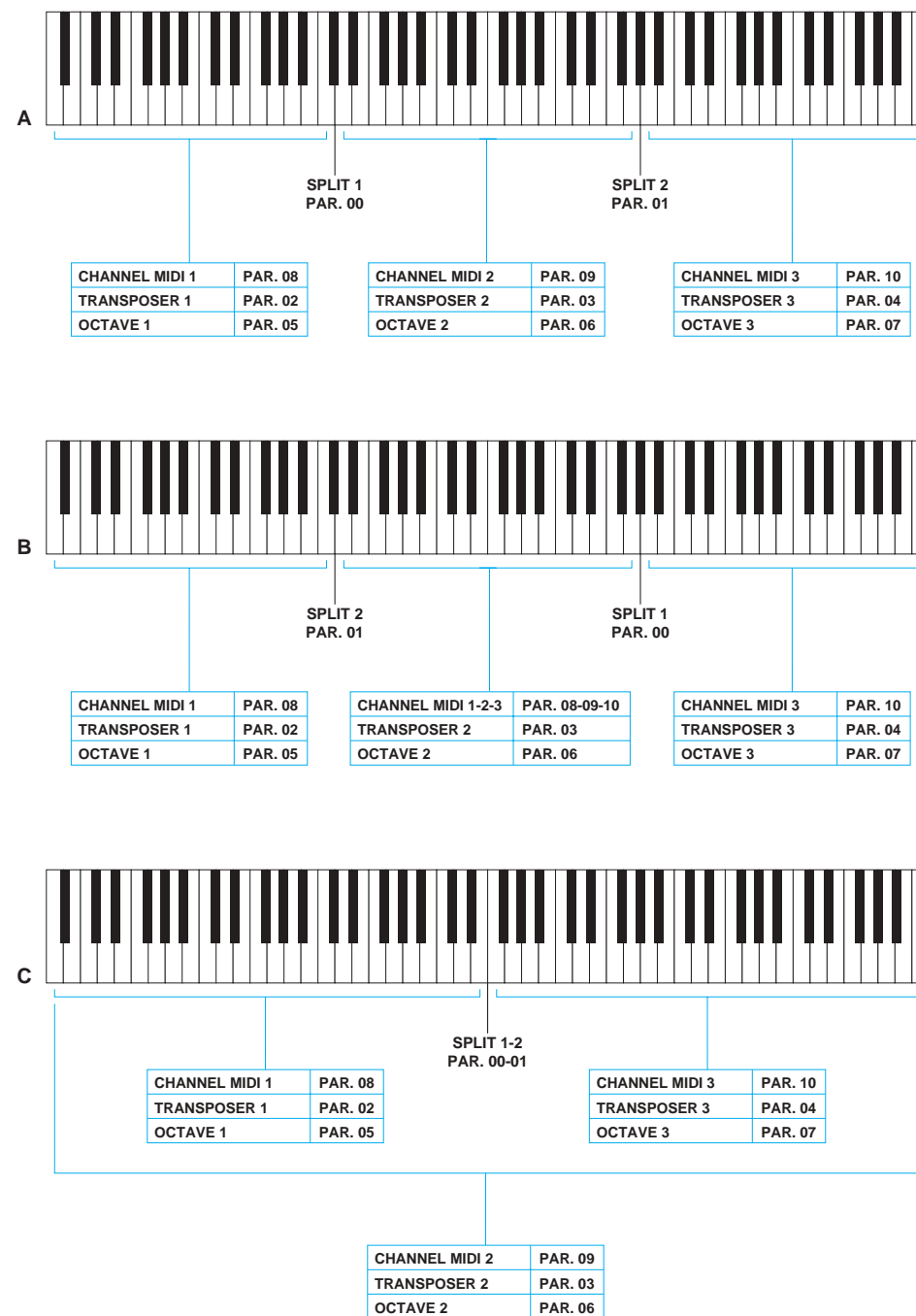

Esempio: Nel programma N. 12 il punto di divisione sinistro si trova sul tasto 17 e il punto di divisione destro nel tasto 42.

Operazione	Tasto	Display	Cosa succede
1	PROG.		tasto programma attivato
2	12	lampegg.	chiamare numero programma
3	ENTER	12	il programma 12 è attivato
4	PARAM.		tasto parametro attivato
5	00	lampegg.	split-point sinistro attivato
6	ENTER	00	parametro attivo
7	VALUE		attivare il tasto value
8	17	lampegg.	chiamato split-point
9	ENTER	17	split sinistro sul tasto 17
10	PARAM.	00	attivato il tasto parametro
11	01	lampegg.	split-point destro attivato
12	ENTER	01	parametro attivo
13	VALUE		attivare il tasto value
14	42	lampegg.	assegnato split-point
15	ENTER	42	split-point attivo

► *TRANSPOSE 1, 2, 3 (Parametri 02, 03, 04)*

Con questo parametro, potete trasporre i vari strumenti fino ad un massimo di 11 semitoni, così da poter intonare uno strumento ad un altro qualora ce ne fosse la necessità, oppure per ottenere effetti di terza e quinta suonando sempre nella stessa tonalità.

Esempio: Nel programma N. 23 la zona sinistra della tastiera dovrà essere trasportata di 4 mezzi toni.

Operazione	Tasto	Display	Cosa succede
1	PROG		attivato tasto programma
2	23	lampegg.	assegnato num. programma
3	ENTER	23	programma 23 attivato
4	PARAM.		attivato il tasto parametro
5	02	lampegg.	assegnato il parametro
6	ENTER	02	parametro attivato
7	VALUE		attivare il tasto value
8	04	lampegg.	assegnato il valore
9	ENTER	04	trasposizione avvenuta

► *OCTAVE 1, 2, 3 (Parametri 05, 06, 07)*

Con questo parametro si possono effettuare trasposizioni per ottave. E' possibile trasportare il suono fino a sette ottave sopra e sette sotto.

Esempio: Nel programma N. 02 la zona sinistra della tastiera deve essere trasportata di 2 ottave sopra, la destra dovrà essere abbassata di 4 ottave. La zona centrale rimane uguale. Attenzione, i due punti di divisione rimangono invariati.

Operazione	Tasto	Display	Cosa succede
1	PARAM.		tasto parametro attivato
2	05	lampegg.	assegnare il parametro
3	ENTER	val. prec.	parametro in funzione
4	VALUE	val. prec.	attivare il tasto value
5	02	lampegg.	assegnato il valore dell'ottava
6	ENTER	02	valore memorizzato
7	PARAM		tasto parametro attivato
8	07	lampegg.	assegnare il parametro
9	ENTER	val. prec.	parametro in funzione
10	VALUE	val. prec.	attivare il tasto value
11	40	lampegg.	assegnato il valore dell'ottava
12	ENTER	40	valore memorizzato

► *CHANNEL MIDI 1, 2, 3 (Parametri 08, 09, 10)*

Questo Parametro ci permette di assegnare il canale MIDI di trasmissione da 1 a 16; ovviamente uno per ogni parte di tastiera.

Esempio: Nel programma N. 17 la zona sinistra della tastiera dovrà suonare il canale MIDI 3.

Operazione	Tasto	Display	Cosa succede
1	PROG		attivato tasto programma
2	07	lampegg.	assegnato num. programma
3	ENTER	07	programma 07 attivato
4	PARAM.	08	attivato il tasto parametro
5	08	lampegg.	assegnato il parametro
6	ENTER	val. prec.	parametro in funzione
7	VALUE	val. prec.	attivato il tasto value
8	03	lampegg.	assegnato il canale MIDI
9	ENTER	03	canale MIDI memorizzato

► PRESET 1, 2, 3 (Parametri 11, 12, 13)

La scelta dei suoni dei vari expanders e strumenti collegati alla STUDIO 90 Plus, avviene attraverso questi parametri, che offrono una possibilità di scelta tra 100 suoni (00-99).

Esempio: Nel programma N. 47 si dovrà mettere la parte centrale della tastiera con il suono 16. Dopo aver chiamato il programma che ci interessa, si procede:

Operazione	Tasto	Display	Cosa succede
1	PARAM.		attivato tasto parametro
2	12	lampegg.	assegnato num. parametro
3	ENTER	val. prec.	parametro attivo
4	VALUE	val. prec.	attivare il tasto value
5	16	lampegg.	assegnato il valore
6	ENTER	16	valore memorizzato

► FOOT-SWITCH/PITCH & MODULATIONS CONTROL 1, 2, 3 (Parametri 14, 15, 16)

Questa è la funzione che ci permette di attivare o disattivare sia il controllo del Sustain (Foot-Switch) che delle due rotelle di controllo Pitch e modulations.

Esempio: vogliamo attivare il Foot-Switch e disattivare le ruote di modulazione nella parte destra della tastiera nel programma 63. Come abbiamo già visto ci si porta sul programma 63 con le solite operazioni, si attiva il tasto VALUE come sappiamo già fare infine si memorizza il nuovo valore intermedio che in questo caso sarà "01".

► VEL SENS. TOUCH (Parametro 17)

Con questa funzione, possiamo regolare il tocco dinamico della tastiera; avendo a disposizione un range molto vasto, è possibile regolare la dinamica giusta sia per il suono che per la tecnica del musicista. Normalmente è posizionato ad un valore intermedio, che si adatta sia alla tecnica del pianista che del tastierista.

► VEL. SENS. RELEASE (Parametro 18)

Questo è invece il controllo dinamico al rilascio, ovvero se volete ottenere degli effetti quando lasciate il tasto, potete controllare la velocità alla quale volete che l'effetto entri in funzione.

E' chiaro che questo parametro funzionerà soltanto se lo strumento collegato accetta questo comando.

MIDI PEDALBOARD

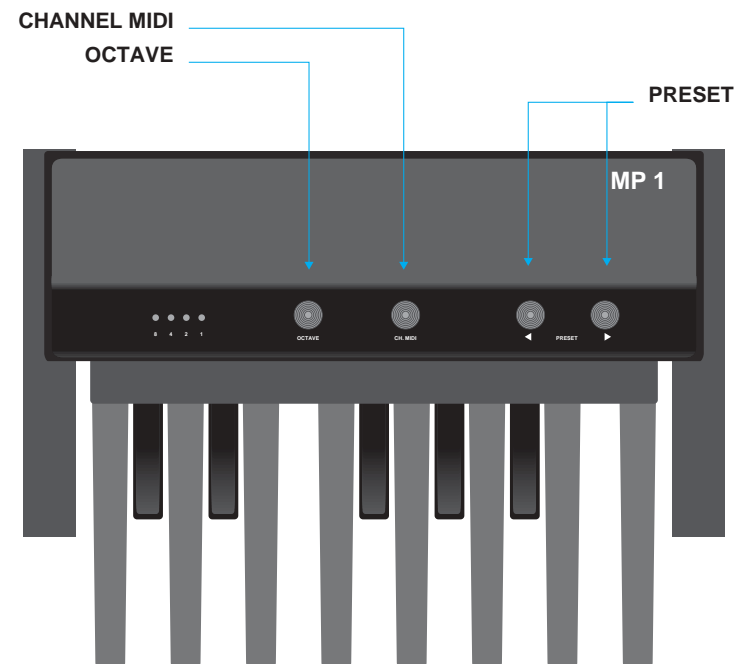

Con la MIDI PEDALBOARD, avete il vostro sistema MIDI non solo ingrandito su di una pedaliera di tredici tasti, ma potete, per esempio, richiamare tutti i suoni che volete da un qualsiasi strumento MIDI ad essa collegato con la possibilità di scelta di un canale MIDI. La MIDI PEDALBOARD, è stata costruita affinché tutte le operazioni possano essere effettuate facilmente ed interamente con i piedi.

► DATI TECNICI

- 13 Tasti
- Posizione delle ottave completamente libera
- Canali MIDI completamente liberi
- Cambio Presets

► CONNESSIONI

- Alimentazione 9 o 12 Volts
- MIDI OUT

► *POSIZIONE DELLE OTTAVE*

Dopo l'attivazione del tasto "OTTAVA" premendo semplicemente uno dei tasti della pedaliera, si decide l'ottava da assegnare:

- DO = Ottava più bassa
- DO # = Ottava sopra
- RE = Ottava sopra
- e così via fino ad arrivare all'ultimo
- DO = Ottava più alta.

► *CANALE MIDI*

Dopo l'attivazione del tasto "CH. MIDI", si assegna il canale MIDI premendo uno dei tasti della pedaliera.

- DO = Canale MIDI 1
- DO # = Canale MIDI 2
- RE = Canale MIDI 3
- fino ad arrivare all'ultimo tasto
- DO = Canale MIDI 13

► *CAMBIO PRESETS*

Con i due tasti ◀ e ▶, si lasciano passare avanti e indietro e vari suoni fino ad arrivare a quello desiderato. Ovviamente il Preset cambierà soltanto nello strumento corrispondente al canale MIDI programmato nella MIDI PEDALBOARD.

Esempio: Vogliamo suonare la MIDI PEDALBOARD con il canale MIDI 11, scegliamo il suono desiderato, ed essendo di tre ottave più basso lo alziamo di tre. Premere il pulsante "CH. MIDI", quindi suonare il tasto "LA"; ora con i tasti ◀ e ▶ andiamo alla ricerca del suono. Ora che abbiamo il suono giusto e il canale MIDI memorizzato, aggiustiamo il Preset trasponendolo di tre ottave sopra: premiamo il pulsante "OTTAVA" quindi il tasto "RE".

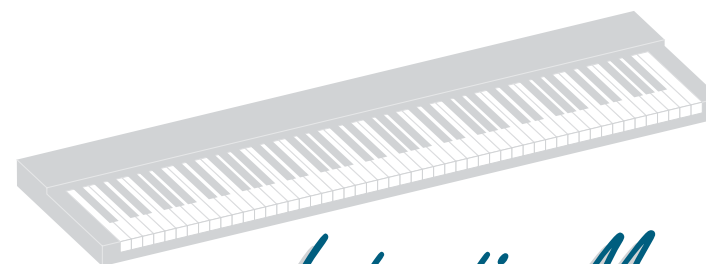

Instruction Manual

STUDIO 90

STUDIO 90 Plus

MIDI PEDALBOARD

MANUFACTURED BY FATAR
WRITTEN BY: J. CORKY COHAN
MUSIC INDUSTRIES

ENGLISH

Note: If you still have questions after thoroughly reading this manual. Please contact Music Industries' Studio-88 Plus, Customer Service Department, at 1-800-6699

STUDIO 90

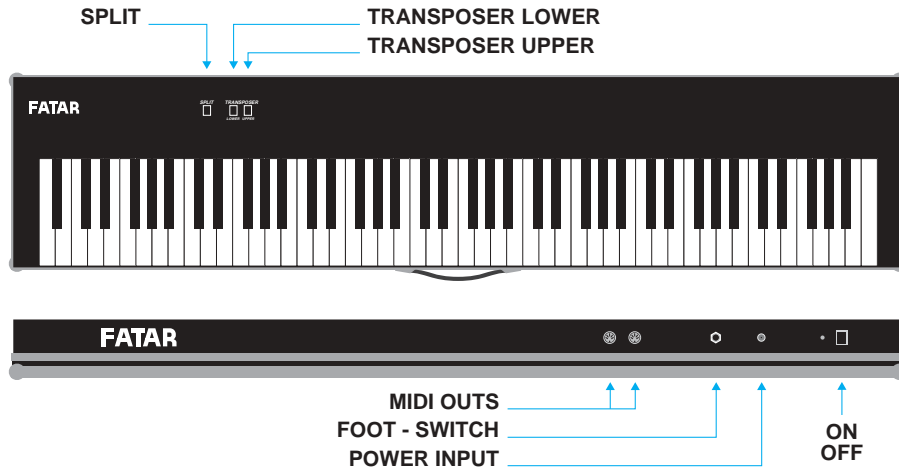

► SPLIT

To split the keyboard in two parts all you do is press the key wish to be the dividing point on the keyboard then press the switch «SPLIT».

Obviously once split, the keyboard is separated in two distinct parts, the LOWER part will go through channel MIDI 1 and the UPPER part through channel MIDI 2. If you press only «SPLIT» and no key the entire keyboard will transmit trough MIDI 1

► TRANPOSER

LOWER: to transpose the LOWER part of the keyboard press the note you want to correspond to initial A then press the switch «LOWER».

UPPER: to transpose the UPPER part of the keyboard press the note you want to correspond to the first key of the split then press «UPPER».

When you split, transposition will be automatic, the lower part will increase by one octave and the upper part decreases by one octave.

► TECHNICAL DATA

Supply will require a standard adapter with a variable continuous out put voltage ranging 9 to 12 V and 350 mA current minimum.

The keyboard includes two midi outputs to pilot other instruments.

Ther is also a FOOT-SWITCH jack to wich you can connect an OFF-ON pedal wich will enable a sustain effect through midi of the popular synthesizers and expanders on the market.

STUDIO 90^{PLUS}



INTRODUCTION:

Thank you for purchasing the FATAR Studio-90 Plus, the finest feeling master controller on the market today. The action is a result of many years of engineering that went into the keyboard mechanism. There are actually hammers that strike a surface that simulates a piano string.

The FATAR Studio-90 Plus master controller is very simple to operate once you understand its capabilities. Even though the controller seems to be always in split mode, you can layer or split one, two, or three sounds across the entire length of the keyboard. However, you must be aware of the specific use of each parameter to get the desired results.

► **FEATURE LIST:** The following is a feature list of the ST-90 Plus master keyboard controller.

Power Supply: 110 V

Fuse: 1A, 250 V, GGS 5 X 20 mm.

88 Note Weighted Hammer Action Keys

Key measurements like a real piano

Dynamic Range (00-99)

Velocity Sensitivity Release (00-99)

Three Zones Programmable

Half-tone transposition

Octave transposition

Three MIDI Outputs

Foot-Switch Control

Program Change Footswitch

Pitch and Modulation Wheels

Outputs on all 16 MIDI Channels (three channels at one time)

100 Performance Programs (00-99)

Two digit numeric display

Beautiful Cabinet Design

Also available in sturdy case road case

► **CONNECTIONS:**

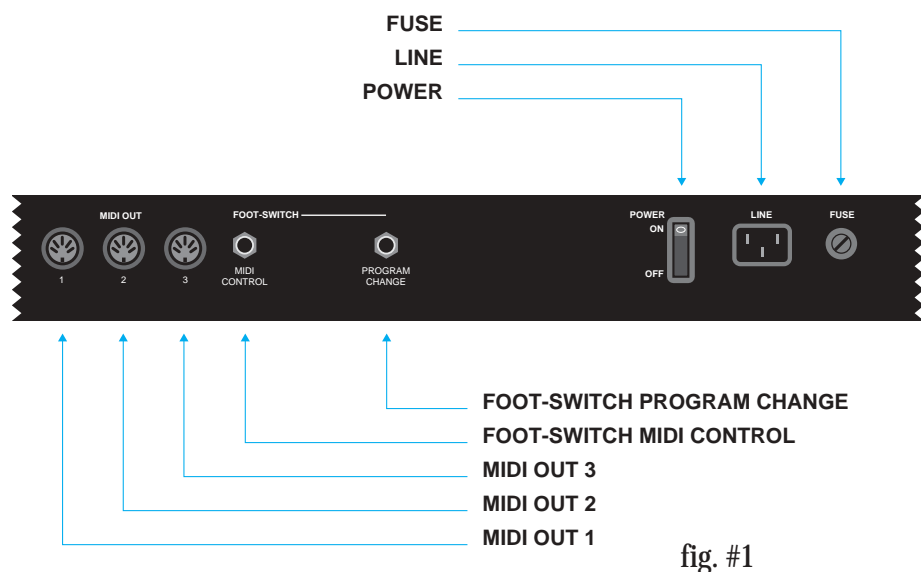

fig. #1

The Studio-90 Plus can be supplied with a road case or with a beautiful designed cabinet. All the functions are the same, but cosmetically they are quite different. The following will explain the difference between the two regarding the back panel.

Look at figure #1. It shows the back panel of the ST-90 Plus built into a road case. Note its three midi outputs. Each output sends out identical information. You can connect four midi sound sources per output, giving you up to twelve sources to choose from. **NEVER CHAIN MORE THAN FOUR MIDI DEVICES PER OUTPUT, THIS CAN CAUSE SOME DELAYS.** If you need more outputs, purchase a thru-box. Located to the right of the midi outputs you will find a 1/4" phone input jack for a foot switch sustain pedal. We recommend a Music Industries PS-10 or a VFP-10 (optional) sustain pedal for this application. We will review the sustain capabilities later on in the next section. To the right of the sustain jack is another 1/4" phone input jack for program advance. You will also review this function later on. Located to the right of the 1/4" jacks you will find the power switch. To the right of power switch is the three pole line cord input and finally the fuse holder. Use a 1 AMP 250V GGS 5 X 20mm when replacing the fuse.

Look at figure #2 and #3. The functions are the same, but the location of the midi outs and foot switch controls are separated from the power section. You will find this configuration on the ST-90 Plus in the cabinet.

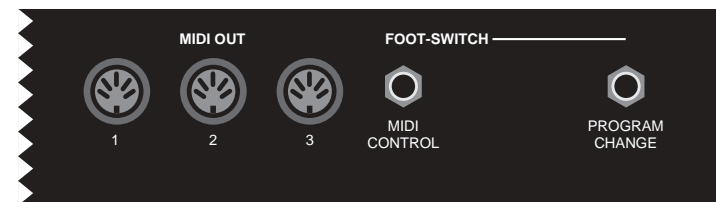

fig. #2

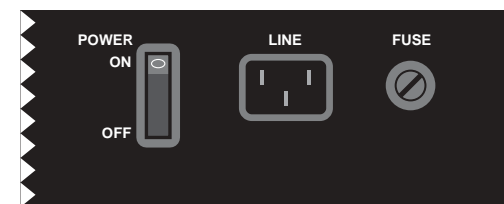

fig. #3

Note: If you want merging capabilities with the Studio-90 Plus, you must use a merge box. A good merge box we recommend is the Pocket Merge from Anatek Microcircuits, Inc. North Vancouver, BC, CANADA.

► **SWITCHING ON:**

To power on the instrument, connect the supplied power cable into "LINE" input and flip the power switch on. Ever time you power up, program 00 will illuminate on the LEDs.

► **NOTE: Studio-90 Plus RESET PROCEDURE:**

If there is ever a time when the Studio-90 Plus acts up in a strange way due to an electrical spike, a reset procedure may be necessary. Turn off power switch. Press switches "ENTER and "1" down together. Turn on power and release "ENTER and "1" after two seconds.

THIS PROCEDURE WILL CANCEL ALL PREVIOUS PROGRAMS AND DEFAULTS UNIT TO FACTORY PRESETS. MAKE SURE YOU WRITE DOWN ALL IMPORTANT PATCH PARAMETERS BEFORE MOVING ON TO CREATE ANOTHER PROGRAM. THERE IS A BLANK PARAMETER CHART IN THE BACK OF THIS MANUAL. MAKE COPIES AND BACK UP YOUR PROGRAMS ON THIS CHART. THIS IS JUST GOOD ADVICE.

▶ SECTION I: GETTING STARTED

In this section we will explore the possibilities of the Studio-90 Plus in its entirety. Do not skip any pages. Since each function depends on a previous parameter, it is probably best to read carefully from here on out.

▶ LET'S GET STARTED

In this section you should get ready for hands on experience. Plug in one end of a midi cable to the output jack of the controller. Plug the other end into the midi input of your sound module. For the first application, even if you have a multi-timbral module, please set a piano or any other sound that you are comfortable with to channel number one. (Multi-timbral means receive on more than one channel at once.) The first application will only deal with channel number one. As you progress you will be adding channels for different keyboard sound combinations. At this time you should have your amplification set up as well. Any other questions dealing with equipment set up, refer to their respective manuals. Once everything is plugged in, power up your system in this order; controller, sound modules, effects, mixer, EQ, and amplifier. This procedure will eliminate any potential hazards to your system.

To program the controller properly you must understand in what sequence to push the buttons to get the desired result. Let's take a look at the program function key located under the two LEDs.

▶ PROGRAMS:

The Studio-90 Plus is equipped with 100 programs, represented numerically between numbers 00 and 99. In order to get from one program to another you must press the buttons in a particular sequence. First, enter program mode by pressing the button marked (prog.). Do this now. A light will illuminate at this time underneath the program button, (when the unit is turned on, the program light will already be illuminated) then enter a program number by pressing two of the numeric keys. (Example, enter program 00, program 05 or any other desired program up to 99).

At this point the numeric LED will flash, then you must press the ENTER* button located to the right of the numeric key pad. This process will lock the desired program into a current working memory location. Do this a couple of times so you

can get the feel of moving through programs. (You will find that the ENTER button must be pressed every time you want a function to work properly regardless what you are attempting to do.) Another way to advance programs, is to use a foot switch plugged into the program change jack, located on the back of the controller. This will advance the programs in numerical order only.

▶ PARAMETERS:

Now you can start programming parameters within a program. Let us start by first picking a program, let's try program 00. If you're not sure how to do this, just reread the last paragraph. OK, now that you are there, you will need to address the parameters and see how they work.

Using the parameters on the Studio-90 Plus is easy once you get a handle on it. If you take a look at top of the controller you will see a listing of nineteen parameters, starting from 00 to 18. In order to access these parameters, press the parameter (param.) button located on the lower left below the two LEDs. Please do this now. You will notice that a red light will illuminate under that parameter button. Now we will choose our first parameter.

▶ SPLIT LEFT-SPLIT RIGHT:

The Studio-90 Plus has two split points represented by parameter 00 (SPLIT LEFT), and parameter 01 (SPLIT RIGHT). You can assign these split points any where on the keyboard. These parameters will allow you to have the controller operate in single mode, split mode or layer mode. For now operate the controller in single mode (one sound across the keyboard). In the next section there will be examples of split and layer mode.

* *Note:* Enter all programs, parameters and values into the memory by pressing the enter key. The enter key acts as a save function.

In order to activate this mode at this time, press the parameter button. Then press 00 on the numeric key pad. At this point the LEDs will flash number 00, now press the ENTER key. This procedure will lock parameter 00 into position and move the red light to the VALUE* function. The VALUE function has a range from 00 to 88 within parameters 00 and 01. You will see how to use different types of VALUES for these parameters later on in this text.

At this time the keyboard is asking you at what key location on the keyboard would you like your first split. You will see a number in the screen. No matter what that number is now, please press 27 on the numeric key pad. This number will flash. Now press the ENTER key to lock this position into the memory of the keyboard. You have just set parameter 00 (SPLIT LEFT) to the 27th key on the keyboard, that is musically speaking, B in the 3rd octave or B3. Repeat this process a couple of times in order to get a feel for the programming.

Let's move on. Now press parameter 01 on the numeric key pad.

At this point the LEDs will flash number 01, now press the ENTER key. This procedure will lock parameter 01 into position and move the red light to the VALUE function. The keyboard is now asking you at what key location on the keyboard would you like your second split. At this time you will see a number in the screen. No matter what that number is now, please press 63 on the numeric key pad. This number will flash. Press the ENTER key to lock this position into the memory of the keyboard. You have just set parameter 01 (SPLIT RIGHT) to the 63rd key on the keyboard that is musically speaking, B in the 6th octave or B6. Repeat this process a couple of times in order to get a feel for the programming.

At this time, the controller's program has three zones. Zone one is from A1 to B3, zone two is from B#3 to B6 and zone three is from B#6 to the highest key of the keyboard. This is where things could get confusing, but do not let it. Remember, you want to get one

** Note: From here on out you must program a VALUE for every parameter in use. VALUE could mean anything from a key location to transposition to program change. We will see how this VALUE works in other situations later on in this text. For now let's just stay with parameter 00 and 01.*

sound across the keyboard. How do you do this if there are three zones across the keyboard? The answer is simple. Locate parameters 08, 09 and 10, these are the midi channel parameters or as the parameter chart refers to it as CHANNEL MIDI 1, 2, and 3. Set each VALUE to number 01, using the method that you already have learned. More about midi channels later.

▶ *TRANSPOSER:*

Locate parameter 02 through 04 on the parameter chart at top of the keyboard that are clearly marked as TRANSPOSER 1, 2, and 3. Use these functions for transposition. Why are there three TRANSPOSER functions? The answer is, there are three zones, so there must be a control for transposition for each zone. Again, look at the parameter chart on top of the keyboard. The number 02 refers to the parameter number, TRANSPOSER refer to the transposition function and 1 refers to zone #1. The same idea applies to parameter 03 and 04 except they refer to TRANSPOSER 2 and 3 for zones 2 and 3. The TRANSPOSER function VALUES are between 00 and 11. These numbers represent semi-tone transposition. You can program each zone up to 11 semi-tones. However, you may only transpose up with these parameters. Do not worry, you can transpose down with the help of the next set of parameters called OCTAVE. Before using the OCTAVE function, you must realize that a VALUE of 00 represents NO transposition. This is important for having one sound across the keyboard chromatically. If on the other hand you need to have some type of transposition, just enter the number of semi-tones you desire.

Example: To program a minor third up you must enter a value of 03 to get the desired result, for a major fifth, enter a value of 07 and so on. After you complete this exercise please enter the value 00 in parameters 02, 03, and 04. In order to create a chromatic state across the keyboard you must adjust the OCTAVE parameters.

▶ *OCTAVE:*

Parameters 05, 06, and 07 refer to OCTAVES 1, 2, and 3. This function controls octave transposition within each zone.

The VALUES of these parameters are 70, 60, 50, 40, 30, 20, 10, 00, 01, 02, 03, 04, 05, 06, and 07. 70 being seven octaves below the natural setting of a piano and 07 being seven octave above. 60 is six octaves below, 06 being six octaves above and so on. VALUE 00 has absolutely no transposition. To create one chromatic sound across the keyboard, set each VALUE for parameters 05, 06, and 07 to VALUE 00. You should now have one chromatic sound across the keyboard without any transposition. If you have reached this point with no problems, please take a break and play your heart out. If you have a problem, please go over each parameter. You might have missed one or two. When you find the incorrect parameter, please correct it, then celebrate. At this point you are half way there.

▶ CHANNEL MIDI:

Parameters 08, 09, and 10 are midi channel functions. You will locate them on the parameter chart as CHANNEL MIDI 1, 2 and 3. Again, 1, 2, and 3, refers for zones one, two, and three. The VALUES of these parameters are midi channels 1 through 16, represented by 01, 02, 03, 04, 05, 06, 07, 08, 09, 10, 11, 12, 13, 14, 15, 16, giving us access to all the midi channels in the specification.

Up to this point you have created a single midi channel. This midi channel runs across the keyboard. By using this procedure you get one chromatic sound from the bottom of the keyboard to the top. What happens if you want three sounds across the keyboard? Well, to start, change each midi channel to a different VALUE. For example, keep parameter 08 the VALUE of 01, but change parameter 09, to VALUE 02 and parameter 10 to VALUE 03. If you have three sound modules chained together by midi cables, please set each one to channel 1, then 2, then 3. If you have one multi-timbral module, set different sounds to channels 1, 2, and 3 (refer to the sound sources' owners manual for the channel change command). At this point you should have different sounds on three separate zones across the keyboard. Check this by playing the keyboard. If you do not have the desired results, check the value of each midi parameter and find your mistake. In the next section you will learn different ways of using midi channels in conjunction with parameters 00, split left and 01, split right, giving you totally different control across the keyboard.

▶ PRESET:

Use parameters 11, 12 and 13 for PRESET changes or program changes. There are 100 program changes. The VALUES of these parameters start at 00 and continue through 99. If the number of the PRESET on the controller does not match the program number on the sound source, do not worry. You will notice that it may be one number off. This is recognized by the MIDI standard. Programming these parameters for each zone is just like programming the previous parameters, only this time you are sending program changes per zone. You will notice that your sound source may have more than 100 sounds. If this is the case, look in the owner's manual for the "program change map". Learn how to use it. In this way you can send patch changes to sounds higher than 100. For example, if the controller sends out a PRESET change of 99, the sound on the receiving end might be 127 or any other number.

In order to get a result like that you must program the program change map so that the transmitting number 99 equals sound 127. There can be any type of number combinations. It is all a matter of your needs.

▶ FOOT SWITCH CONTROL:

Parameter 14, 15, and 16 allows the possibility to enable or disable the sustain foot switch and or the wheel function for each zone. The programming routine is the same as the other parameters.

The VALUES of these parameters are as follows; 00 = foot switch off, modulation wheel off; 01 = foot switch on, modulation wheel off; 02 = foot switch off, modulation wheel on; 03 = foot switch on, modulation wheel on.

The Studio-90 Plus factory default is 03, so sustain and wheels are on, on all zones. However, you might be in a situation that calls for the wheels and or sustain must be off. Here is a good example. Program three split zones across the keyboard. Assign the left zone to a bass sound. Then program the wheel control but not sustain. Then assign the middle zone to a piano sound with sustain but without wheel control. Finally, assign the right zone to have a lead sound with wheel and sustain control. The parameter and VALUE assignment would be as follows; parameter 14 = VALUE 02, parameter 15 = VALUE 01, and parameter 16 = VALUE 03. Keep in mind this is just an example. You can program these parameters in many ways to suit your needs.

▶ VELOCITY SENSITIVITY:

Parameter 17 controls the velocity sensitivity response. With this parameter you can control the way sound responds dynamically through velocity. A VALUE of 99 gives you a very short dynamic range with the sound responding to a high velocity, such as 127 when a key is played softly. A VALUE of 00 has a very big dynamic range with the sound responding to a 3/4 velocity when the key is played hard. The keyboard defaults at VALUE 50. This gives you a superb linear action with a great dynamic range suitable for most needs.

VELOCITY SENSITIVITY RELEASE:

Parameter 18 controls the release velocity. Release velocity generally controls a function in the sound source that corresponds to the release parameter of a sound

envelope. The result is a fast or slow release of the sound. VALUE 99 has a quick response and 00 has a slow response. The default of the keyboard is 50. Program parameter 18 in the same manor as the other parameters. NOTE: In order for this function to work, the sound source must have the capability of receiving such a command. Some sound sources let you use this release function for other control parameters. Check your sound source owner's manual for details.

SECTION II: SAMPLE SET-UP

This section will give you examples of set ups that may be useful to you. Save each set up in its own program. This section is only meant to help you get a handle on how to use this controller for different applications. You must know how to program the controller before you can use this section. Only PARAMETER and VALUE numbers will be supplied.

NOTE: You will be given PARAMETERS 00 through 18. PARAMETERS 00 through 10 deals with the physical set up of the controller for each set up. You must use these parameters. Note the midi channels, they do not have to be the exact number, but be aware of their use. PARAMETER 11 through 17 deals with your personal tastes in mind. They are listed here as a guide line and only should be used as a reference. Any questions on the use of these parameters please review in section one. The following programs were designed with EMU Proteus and Proformance modules.

One sound Across Keyboard			
▶ 00 = 27	▶ 10 = 01		
▶ 01 = 63	▶ 11 = 00		
▶ 02 = 00	▶ 12 = 00		
▶ 03 = 00	▶ 13 = 00		
▶ 04 = 00	▶ 14 = 03		
▶ 05 = 00	▶ 15 = 03		
▶ 06 = 00	▶ 16 = 03		
▶ 07 = 00	▶ 17 = 50		
▶ 08 = 01	▶ 18 = 50		
▶ 09 = 01	▶ -		

Note: All parts split across the keyboard.

Two Sound Split at C5			
▶ 00 = 27	▶ 10 = 03		
▶ 01 = 40	▶ 11 = 01		
▶ 02 = 00	▶ 12 = 01		
▶ 03 = 00	▶ 13 = 19		
▶ 04 = 00	▶ 14 = 03		
▶ 05 = 01	▶ 15 = 03		
▶ 06 = 01	▶ 16 = 03		
▶ 07 = 20	▶ 17 = 50		
▶ 08 = 02	▶ 18 = 50		
▶ 09 = 02	▶ -		

Note: Part 1 & 2 same midi channel, part 3 different midi channel.

Three Sounds Split at B3 and B6			
▶ 00 = 27	▶ 10 = 03		
▶ 01 = 63	▶ 11 = 08		
▶ 02 = 00	▶ 12 = 00		
▶ 03 = 00	▶ 13 = 33		
▶ 04 = 00	▶ 14 = 03		
▶ 05 = 01	▶ 15 = 03		
▶ 06 = 00	▶ 16 = 03		
▶ 07 = 30	▶ 17 = 50		
▶ 08 = 02	▶ 18 = 50		
▶ 09 = 01	▶ -		

Note: Part 1, 2 & 3 used across keyboard.

One Sound Left of C5, Two Sounds Right			
▶ 00 = 40	▶ 10 = 04		
▶ 01 = 88	▶ 11 = 32		
▶ 02 = 00	▶ 12 = 05		
▶ 03 = 00	▶ 13 = 10		
▶ 04 = 00	▶ 14 = 03		
▶ 05 = 00	▶ 15 = 03		
▶ 06 = 00	▶ 16 = 03		
▶ 07 = 00	▶ 17 = 50		
▶ 08 = 02	▶ 18 = 50		
▶ 09 = 03	▶ -		

Note: Part 1 to C5, part 2 & 3 from C#5 to top of keyboard.

One Sound Across keyboard, Two more Layered Above C5			
▶ 00 = 88	▶ 10 = 03		
▶ 01 = 40	▶ 11 = 00		
▶ 02 = 00	▶ 12 = 10		
▶ 03 = 00	▶ 13 = 02		
▶ 04 = 00	▶ 14 = 01		
▶ 05 = 00	▶ 15 = 02		
▶ 06 = 00	▶ 16 = 02		
▶ 07 = 00	▶ 17 = 50		
▶ 08 = 01	▶ 18 = 50		
▶ 09 = 02	▶ -		

Note: Part 1 across keyboard, part 2 & 3, C#5 to top of keyboard.

Three Sounds Left of C5, One Sound Above			
▶ 00 = 40	▶ 10 = 04		
▶ 01 = 00	▶ 11 = 07		
▶ 02 = 00	▶ 12 = 05		
▶ 03 = 00	▶ 13 = 01		
▶ 04 = 00	▶ 14 = 03		
▶ 05 = 00	▶ 15 = 03		
▶ 06 = 01	▶ 16 = 03		
▶ 07 = 10	▶ 17 = 50		
▶ 08 = 02	▶ 18 = 50		
▶ 09 = 03	▶ -		

Note: Part 1 & 2 up to C#5, part 3, C#5 to top of keyboard.

Two Sounds Layered to C5, One Sound Above			
▶ 00 = 00	▶ 10 = 04		
▶ 01 = 40	▶ 11 = 06		
▶ 02 = 00	▶ 12 = 07		
▶ 03 = 00	▶ 13 = 01		
▶ 04 = 00	▶ 14 = 03		
▶ 05 = 00	▶ 15 = 03		
▶ 06 = 00	▶ 16 = 03		
▶ 07 = 10	▶ 17 = 50		
▶ 08 = 02	▶ 18 = 50		
▶ 09 = 03	▶ -		

Note: Part 1 & 2 up to C#5, part 3, C#5 to top of keyboard.

Three Sounds Across Keyboard			
▶ 00 = 88	▶ 10 = 04		
▶ 01 = 00	▶ 11 = 09		
▶ 02 = 00	▶ 12 = 10		
▶ 03 = 00	▶ 13 = 43		
▶ 04 = 00	▶ 14 = 03		
▶ 05 = 00	▶ 15 = 03		
▶ 06 = 00	▶ 16 = 03		
▶ 07 = 00	▶ 17 = 50		
▶ 08 = 02	▶ 18 = 50		
▶ 09 = 03	▶ -		

Note: All parts across the keyboard layered.

PARAMETER CHART

Program Name _____

Program Number _____

00 =
01 =
02 =
03 =
04 =
05 =
06 =
07 =
08 =
09 =
10 =
12 =
13 =
14 =
15 =
16 =
17 =
18 =

Notes: _____

MIDI PEDALBOARD

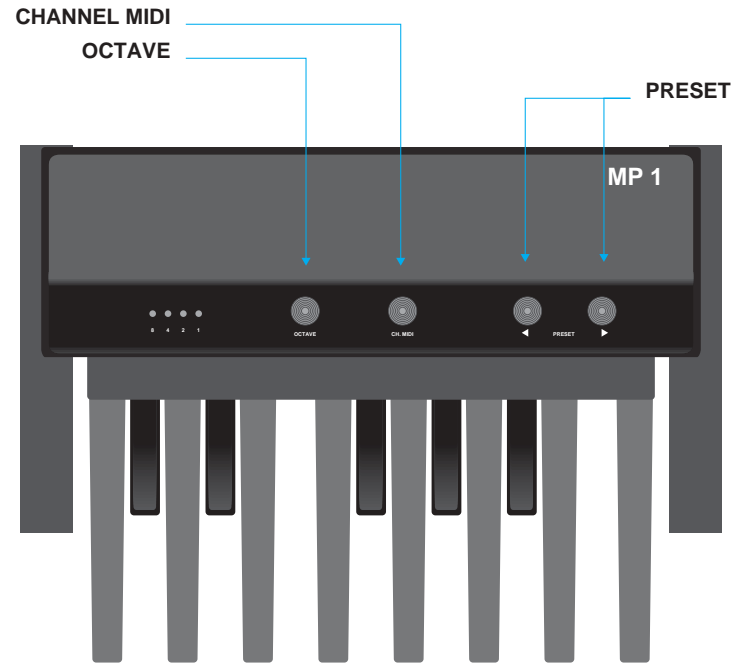

With the MIDI PEDALBOARD you have a wider MIDI system, and you also have the possibility to change the sounds and the octave in an expander. The MIDI PEDALBOARD is manufactured so that all functions can be easily executed by feet.

► *FEATURES*

- 13 Keys
- Programmable octave
- Programmable MIDI channel
- Change program
- MIDI outputs

► *CONNECTIONS*

- Power supply 9 - 12 Volts
- MIDI OUT

PROGRAMMING POSSIBILITIES

► POSITIONS OF OCTAVES

By depressing OCTAVE switch, you can assign a certain bass pedal octave positions to any Pedalboard key.

example:

- C on Pedal = Lower octave
- C # on Pedal = One octave more
- D on Pedal = One octave more
- C high = Octave heigher

► MIDI CHANNELS

By depressing CH. MIDI switch you can the MIDI channel to any Pedalboard key.

example:

- C on Pedal = Lower octave
- C # on Pedal = One octave more
- D on Pedal = One octave more
- C high = Octave heigher

► PRESETS EXTENSION SWITCH

With switches ◀ and ▶, you can send MIDI-voice throught the MIDI channel in function.



Instruction Manual

STUDIO 90

STUDIO 90 Plus

MIDI PEDALBOARD

DEUTSCH

STUDIO 90

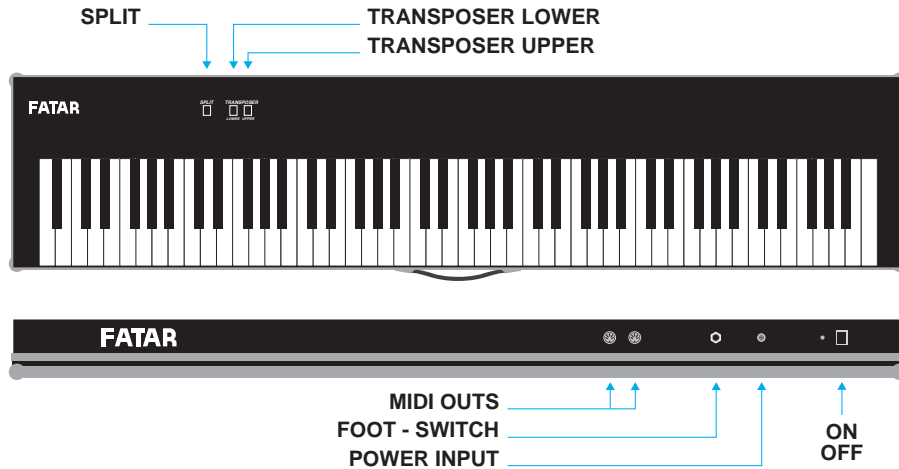

▶ TRENNUNG

Um die Tastatur in zwei Teile zu trennen, genügt es, die Note zu drücken, von der die Tastatur geteilt werden soll, dann drückt man die Taste "SPLIT".

Nach der Trennung, teilt sich die Tastatur in zwei Teile: der Unterteil (LOWER) ist im MIDI 1 Kanal und der Oberteil (UPPER), im MIDI 2 Kanal. Wenn man die Taste "SPLIT" ohne die Note drückt, wird die ganze Tastatur im MIDI 1 Kanal gesendet.

▶ TRANSPOSER

LOWER: um den Unterteil (LOWER) zu transponieren, genügt es die Note zu drücken, die der Anfangstaste «A» gleichkommen soll, dann drückt man die Taste "LOWER".

UPPER: um den Oberteil (UPPER) zu transponieren, genügt es die Note zu drücken, die der ersten Taste der Trennung gleichkommen soll, dann drückt man die Taste "UPPER". Wenn man die Tastatur teilt, kommt es zu einer automatischen Transponierung: der Unterteil wird um eine Oktave höher während der Oberteil eine Oktave sinkt.

▶ TECHNISCHE DATEN

Die Speisung wird von einem Standard-Adapter gegeben, der eine Ausgangsleitung von 9 bis 12 Volt (fortdauernd) hat und einem Mindeststrom von 350 mA. Die Tastatur ist mit zwei MIDI Ausgängen versehen, damit man zwei äussere Instrumente direkt steuern kann. Ausserdem ist ein FOOT-SWITCH Ausgang vorhanden, an dem man einen Fußschweller OFF-ON anschließen kann, der einen Effekt Sustain über MIDI auf den meistbekanntesten Sintetizzatoren und Expandern erzeugt.

STUDIO 90 Plus



▶ EIGENSCHAFTEN

- Netzanschluß 220-240 Volt
- Sicherung 500 mA
- Eingebaute Batterie zur Program-Sicherung
- 88 gewichtete Tasten (für STUDIO 90 Plus)
- Anschlagdynamik (0-99)
- Dynamikabhängige Release-Control (00-99)
- Original Piano-Mensur
- Original Akustik-Piano-Anschlag
- Zwei frei wählbare Key-Split's
- Halbton-Transposer für alle drei Tastaturbereiche
- Oktave-Transposer für alle drei Tastaturbereiche
- 3 MIDI-Ausgänge
- Fußschalterbuchse MIDI-Control
- Fußschalterbuchse für Programmwechsel
- Fußschalterfunktionen programmierbar
- Pitch Wheel für jeden Keyboardbereich
- Modulation Wheel für jeden Keyboardbereich
- 16 frei wählbare Midi-Kanäle
- 100 frei wählbare Presetnummern
- Display-Anzeige
- Flightcase
- Cabinet

▶ **GENERALPROGRAMMIERUNG (STUDIO 90 Plus)**

Das Manual ausschalten.

Die Tasten "ENTER" und "1" von der Nummerntastatur gedrückt halten.

Die o.g. Tasten immer gedrückt halten und gleichzeitig das Manual einschalten.

Wichtig: Die Generalprogrammierung löscht alle Programme die Sie gespeichert haben.

▶ **ANSCHLÜSSE** Bevor Sie mit dem Spiel auf Ihrem STUDIO 90 Plus beginnen können, müssen Sie die notwendigen Anschlüsse herstellen.

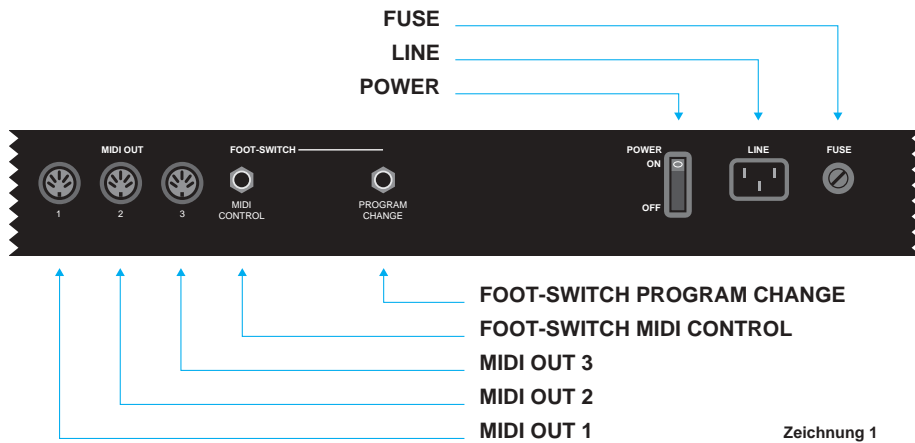

Zeichnung 1

▶ **NETZANSCHLÜßE**

Netzkabel in den Eingang "LINE" auf der Rückseite des STUDIO 90 Plus und in eine vorschriftsmäßig installierte Schuko-Steckdose einstecken. (Siehe Zeichnung N° 1)

▶ **MIDI-AUSGÄNGE (MIDI OUT)**

Das STUDIO 90 Plus ist mit drei MIDI-Ausgängen ausgestattet. Diese MIDI-Ausgänge erlauben es, mehrere MIDI-Instrumente gleichzeitig anzuschließen, auch wenn diese keine "MIDI-THRU" - Buchse besitzen

▶ **PARAMETERN UND WERTE (STUDIO 90 Plus)**

▶ PARAMETER	▶ FUNKTION	▶ VALUE (WERT)
▶ 00	▶ Splitpunkt left	▶ 00-88
▶ 01	▶ Splitpunkt right	▶ 00-88
▶ 02	▶ Transposer 1	▶ 00-11
▶ 03	▶ Transposer 2	▶ 00-11
▶ 04	▶ Transposer 3	▶ 00-11
▶ 05	▶ Octave 1	▶ 70-00-07
▶ 06	▶ Octave 2	▶ 70-00-07
▶ 07	▶ Octave 3	▶ 70-00-07
▶ 08	▶ Midi out 1	▶ 01-16
▶ 09	▶ Midi out 2	▶ 01-16
▶ 10	▶ Midi out 3	▶ 01-16
▶ 11	▶ Instr.-Preset 1	▶ 00-99
▶ 12	▶ Instr.-Preset 2	▶ 00-99
▶ 13	▶ Instr.-Preset 3	▶ 00-99
▶ 14	▶ FT.SW. Control 1	▶ 00=off FS/Mod 01=on FS off Mod 02=off FS on Mod 03=on FS Mod
▶ 15	▶ FT.SW. Control 2	
▶ 16	▶ FT.SW. Control 3	
▶ 17	▶ Vel. Sens. Touch	▶ 00-99
▶ 18	▶ Vel. Sens. Release	▶ 00-99

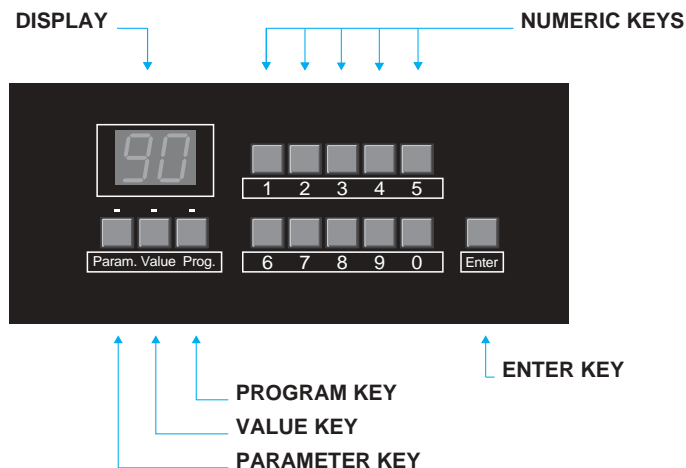

► **SPLITPUNKTE** (Parameter 00 und 01).
 Das Studio 90 Plus hat zwei völlig frei wählbare Splitpunkte. Dies erlaubt eine Unterteilung des Manuals in maximal drei unterschiedliche Bereiche. Aus diesem Grunde sind einige Parameter mit 1, 2 oder 3 bezeichnet. Dabei ist "3" immer der linke Manualbereich, "2" ist der mittlere und "1" der rechte Manualabschnitt.
 Ist nur der linke Splitpunkt gesetzt, sind die Manualbereiche "3" (links) und "2" (rechts) aktiv; ist nur der rechte Splitpunkt gesetzt, sind die Manualbereiche "2" (links) und "1" (rechts) aktiv.
 Ist der Parameter "00" (Linker Splitpunkt) auf Wert "01" und der Parameter 01 auf den Wert 87 gesetzt, kann das ganze Keyboard mit nur einem Sound gespielt werden (dann ist nur Manualbereich "2" aktiv).

Neben diesen "Normaleinstellungen" (siehe auch Abb. 2) gibt es noch zwei weitere Sondereinstellungen:
 Abbildung 2 zeigt das Überlappen zweier Splitpunkte. Der linke und der rechte Teil des Manuals lassen sich weiterhin in der bisherigen Einstellung spielen. Der mittlere Bereich (zwischen den sich überschneidenden Splitpunkten) kann nun alle drei MIDI-Kanäle gleichzeitig spielen; Einstellen der Stimmung über die Parameter 03 (Transposer 2) und 06 (Octave 2).
 Liegt der rechte und der linke Splitpunkte auf der gleichen Taste (Siehe Abb. 3) wird der rechte und der linke Manualteil gemäß der Einstellungen für MIDI-Kanal 1 und 3 registriert. Gleichzeitig kann das gesamte Manual mit der Klangfarbe von MIDI-Kanal 2 gespielt werden.

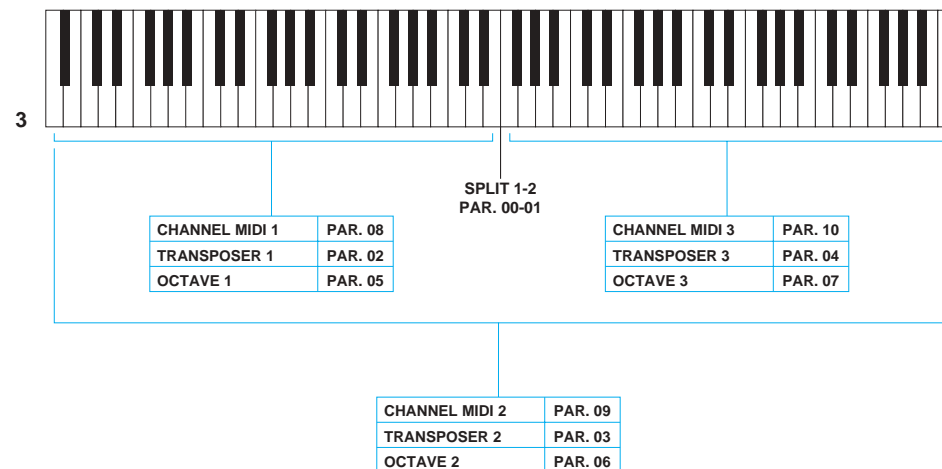
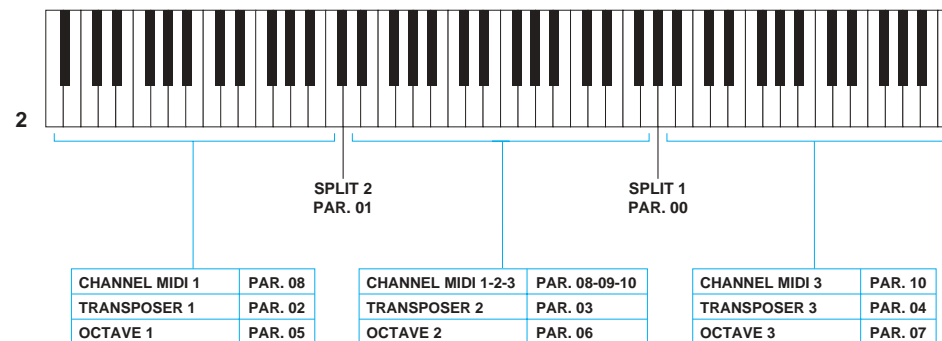
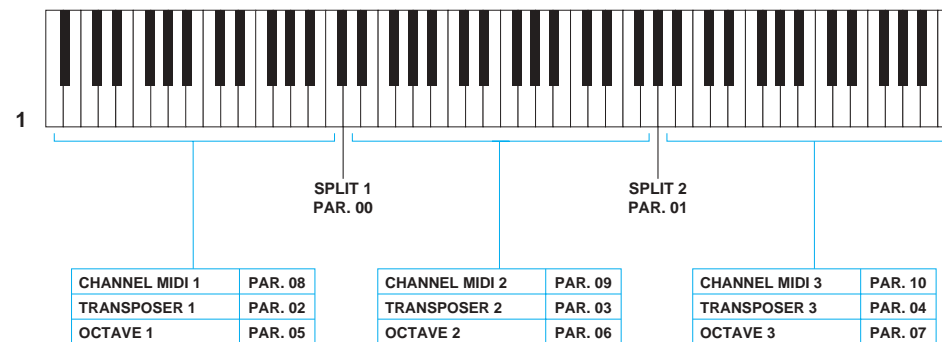

Beispiel: Im Programm Nr. 12 soll der linke Splitpunkt bei Taste Nr. 17 und der rechte Splitpunkte bei Taste Nr. 42 liegen.

Schritt	Taster	Display	Aktion
1	PROG.		Programm-Taster aktivieren
2	12	12 blinkt	Eingabe der Programm-Nummer
3	ENTER	12	Programm-Nr. 12 ist aktiv
4	PARAM.	*	Parameter-Taster aktivieren
5	00	00 blinkt	Eingabe der Param. 00="Splitpunkt links"
6	ENTER	*	"Splitpunkt links" - Param. ist aktiviert
7	VALUE	*	"Werte - Taster" aktivieren
8	17	17 blinkt	Taste Nr. 35 (G) eingeben
9	ENTER	17	linker Splitpunkt bei Taster Nr.17 ist gesetzt
10	PARAM.	00	Parameter-Taster aktivieren
11	01	01 blinkt	Eingabe der Param. 01="Splitpunkt rechts"
12	ENTER	*	"Splitpunkt rechts" - Param. ist aktiviert
13	VALUE	*	"Werte - Taster" aktivieren
14	42	42 blinkt	Taste Nr. 42 eingeben
15	ENTER	42	rechter Splitpunkt bei Taster Nr.42 ist gesetzt

*) abhängig von der letzten Programmänderung

Damit sind die beiden Splitpunkte an der gewünschten Stelle gesetzt. Versuchen Sie einmal andere Splitpunkte einzustellen. Gehen Sie dabei immer in der gezeigten Reihenfolge vor und denken Sie stets daran:

alle Eingaben sind erst gespeichert, wenn die Taste "ENTER" betätigt wurde.

In der selben Art und Weise verfahren Sie mit den anderen Parametern.

▶ TRANSPOSE 1, 2, 3 (Parameteri 02, 03, 04)

Sie haben die Möglichkeit, die verschiedenen Manualbereiche 1, 2 und 3 unter schiedlich in maximal 11 Halbtonschritten (00 bis 11) zu transponieren. Dadurch ist es möglich, sich anderen Instrumenten anzupassen, oder aber spezielle Effekte zu erzielen

Beispiel: Im Programm Nr.23 soll der linke Manualbereich um 4 Halbtöne transponiert werden.

Schritt	Taster	Display	Aktion
1	PROG		Programm-Taster aktivieren
2	23	23 blinkt	Eingabe der Programm-Nummer
3	ENTER	23	Programm-Nr. 23 ist aktiv
4	PARAM.	*	Parameter-Taster aktivieren
5	02	02 blinkt	Eingabe der Param. 02="Transpose 3" (linker Manualbereich)
6	ENTER	02	"Transpose 3" - Parameter ist aktiviert
7	VALUE	*	"Werte - Taster" aktivieren
8	04	04 blinkt	Transpose-Wert eingeben (4 Halbtonschritte)
9	ENTER	04	der linke Manualbereich ist um 4 Halbtöne nach oben transponiert

*) abhängig von der letzten Programmänderung

Entsprechend gehen Sie vor, wenn Sie den mittleren (Parameter "03") oder rechten Manualbereich (Parameter "04") transponieren wollen.

▶ OCTAVE 1, 2, 3 (Parameter 05, 06, 07)

Diese Parameter erlauben für jeden Manualbereich eine oktavweise Transponierung bis zu maximal 7 Oktaven nach oben oder unten.

Voraussetzung ist jedoch, daß das angeschlossene Instrument über den entsprechenden Tonumfang verfügt.

Soll nach oben transponiert werden, ist der Wert (VALUE) in der Reihenfolge "null-Oktavwert" einzugeben, also 01, 02,03 ... und so weiter.

Beispiel: (Wir befinden uns im Programm Nr.02). Der linke Manualbereich soll um zwei Oktaven erhöht der rechte um 4 Oktaven erniedrigt werden. Der mittlere Manualbereich bleibt unbeeinflußt. Beachten Sie, daß zwei Splitpunkte festgelegt sind.

Schritt	Taster	Display	Aktion
1	PARAM.	02	Parameter-Taster aktivieren
2	05	05 blinkt	
3	ENTER	*	"Oktave 3" - Parameter ist aktiviert
4	VALUE	05	"Werte - Taster" aktivieren
5	02	02 blinkt	Oktave-Wert eingeben (2 Oktaven nach oben)
6	ENTER	02	der linke Manualbereich ist um 2 Oktaven nach oben transponiert
7	PARAM	*	Parameter-Taster aktivieren
8	07	07 blinkt	Eingabe der Param. 07="Oktave 1" (Rechter Manualbereich)
9	ENTER	*	"Oktave 1" - Parameter ist aktiviert
10	VALUE	*	"Werte - Taster" aktivieren
11	40	40 blinkt	Oktave-Wert eingeben (4 Oktaven nach oben)
12	ENTER	40	der linke Manualbereich ist um 4 Oktaven nach oben transponiert

*) abhängig von der letzten Programmänderung

▶ CHANNEL MIDI 1, 2, 3 (Parameter 08, 09, 10)

Über diese Parameter können die MIDI-Kanäle von 1 bis 16 frei gewählt werden. Sinnvollerweise wählt man für jeden der drei möglichen Manualbereich einen unterschiedlichen Kanal. Gehen Sie vor, wie in den bereits verschriebenen Beispielen.

Beispiel: Im Programm Nr.07 soll der linke Manualbereich über den MIDI-Kanal 3 gesendet werden. (Entsprechend verfahren Sie beim Einstellen der MIDI-Kanäle für den mittleren und rechten Manualbereich).

Schritt	Taster	Display	Aktion
1	PROG		Programm-Taster aktivieren
2	47	47 blinkt	Eingabe der Programm-Nummer
3	ENTER	47	Programm-Nr. 47 ist aktiv
4	PARAM.	*	Parameter-Taster aktivieren
5	12	12 blinkt	Eingabe der Parameters 12="PRESET 2"
6	ENTER	*	"PRESET 2" - Parameter ist aktiviert
7	VALUE	*	"Werte - Taster" aktivieren
8	16	16 blinkt	Klangfarbe Nr. 16 eingeben
9	ENTER	16	Klangfarbe Nr. 16 für den mittleren Manualbereich ist gesetzt

*) abhängig von der letzten Programmänderung

▶ PRESET 1, 2, 3 (Parameter 11, 12, 13)

Die Wahl der Klangfarben des angeschlossenen Instrumentes für jeden der Manualbereich nehmen Sie über die Parameter "11, 12 und 13" vor. Bis zu 100 verschiedene Klänge und Sounds (00-99) können über den aktiven MIDI-Kanal aufgerufen und zugeordnet werden.

Beispiel: Im Programm Nr. 47 soll der mittlere Manualbereich mit der Klangfarbe Nr.16 belegt werden

Schritt	Taster	Display	Aktion
1	PARAM.		Programm-Taster aktivieren
2	47	47 blinkt	Eingabe der Programm-Nummer
3	ENTER	47	Programm-Nr. 47 ist aktiv
4	PARAM.	*	Parameter-Taster aktivieren
5	12	12 blinkt	Eingabe der Parameters 12="PRESET 2"
6	ENTER	*	"PRESET 2" - Parameter ist aktiviert
7	VALUE	*	"Werte"-Taster aktivieren
8	16	16 blinkt	Klangfarbe Nr. 16 eingeben
9	ENTER	16	Klangfarbe Nr. 16 für den mittleren Manualbereich ist gesetzt

*) abhängig von der letzten Programmänderung

▶ FUSSTASTER MODE CONTROL 1, 2, 3 (Parameter 14, 15, 16)

Ist an der Buchse "MIDI-Control" ein Fußtaster angeschlossen, kann mittels der Parameter 14, 15 und 16 bestimmt werden, in welchem Manualbereich der Fußtaster die Sustain-Funktion auslöst. Weiterin wird festgelegt, ob und in welchem Manualbereich die Wheels (Modulations-Räder) aktiv sind.

Beispiel: Im Programm Nr. 63 sollen Fußtaster und Wheel 2 für den rechten Manualbereich aktiv sein.

▶ VELOCITY SENSITIVITY TOUCH (Dynamik-Empfindlichkeit) (Parameter 17)

Die Empfindlichkeit der Anschlagdynamik kann über diesem Parameter von "00" bis "99" eingestellt werden, je nach persönlicher Anschlagstärke. Im Allgemeinen sollte die Empfindlichkeit auf einen mittleren Wert (40-60) eingestellt sein, um einen normalen Piano-bzw. Keyboardanschlag zu erhalten.

▶ VELOCITY SENSITIVITY RELEASE (Parameter 18)

Dieser Parameter kontrolliert die Dynamik des "Taste-Loslassens". d.h. soll ein Effekt erst nach dem Loslassen der Tasten ausgelöst werden, kann bestimmt werden, ab welcher "Dynamik" der Effekt aktiviert wird. Dies ist jedoch nur möglich, wenn das angeschlossene Gerät dieses Kommando akzeptiert.

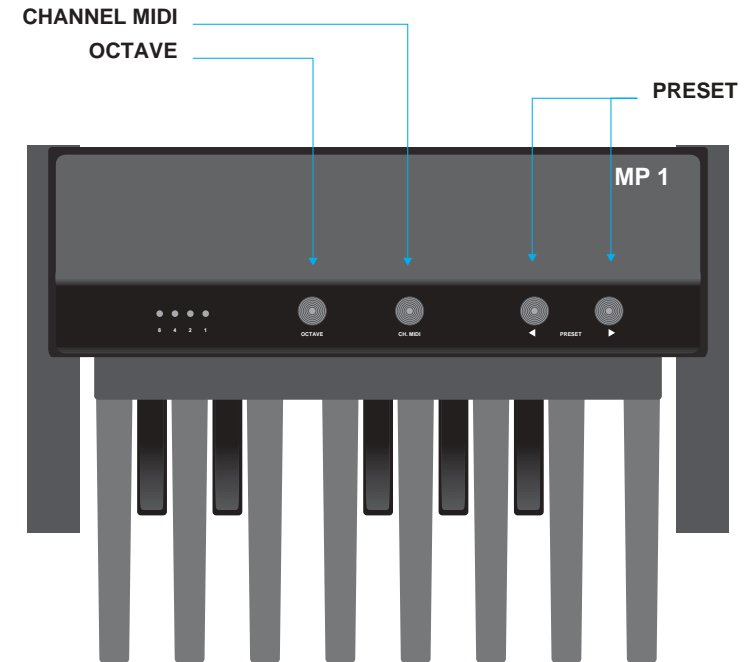

Mit dem MIDI-PEDAL haben Sie Ihr MIDI-System nicht nur um ein 13-Tasten-Pedal erweitert, sondern Sie können z.B. auch über das Pedal Registrierungen (Klangfarben) aus dem Expander abrufen. Dabei wurde das MIDI-Pedal so konstruiert, dass alle Funktionen leicht mit den Füßen durchgeführt werden können.

▶ DIE TECHNISCHEN DATEN:

- 13 Tasten
- Frei wählbare Oktavlage
- Frei wählbarer MIDI-Kanal
- Instrument-change (Klangfarbenwechsel)

▶ ANSCHLÜSSE:

- Netzanschluß (9 oder 12 Volt)
- MIDI OUT

PROGRAMMIERMÖGLICHKEITEN

▶ 1.0 OKTAVLAGE

Nach dem Betätigen des Tasters "OKTAVE" läßt sich die Oktavlage des Basspedals über die Pedaltasten einstellen:

- C = tiefste Oktave
- Cis = eine Oktave höher u.s.w.

Nach jedem Betätigen des Tasters "OKTAVE" kann man immer nur einen Oktave-Wert einstellen. Ggf. erneut den "OKTAVE"-Taster drücken.

▶ 2.0 MIDI-KANAL

Nach Betätigen des Tasters "Ch. MIDI" lassen sich in gleicher Weise die MIDI-Kanäle einstellen:

- C = MIDI-Kanal 1
- Cis = MIDI-Kanal 2 u.s.w.

▶ 3.0 WEITERSCHALTEN DER KLANGFARBEN

Mit den beiden Pfeiltastern ◀ und ▶ lassen sich die MIDI-Voice-Nummern (Klangfarben) auf dem eingestellten MIDI-Kanal vor- bzw. zurückschalten.

Die vielfältigen Möglichkeiten, die Ihnen die Keyboards bzw. das MIDI-Pedal bieten, werden Sie erst nach einigem Ausprobieren und Experimentieren vollständig nutzen können. Wir wünschen Ihnen also viel Freude beim Kennenlernen Ihres neuen Instrumentes.

WARNUNG/VDE - VORSCHRIFTEN

Arbeiten unter Netzspannung können lebensgefährlich sein und sollten nur von einem Fachmann durchgeführt werden.

Bei Sicherungstausch oder eventueller Fehlersuche im Netzspannungsbereich (Netzeinbaustecker, Trafo, Netzschalter) grundsätzlich den Netzstecker ziehen!